

Forno Bravo

Professionale120-FA

v1.1 03/11

© Forno Bravo, LLC 2011

744 Neeson Road

Marina, CA 93933

(800) 407-5119

www.fornobravo.com

Clearances

1" on sides, 14" on top.

Fuel

Wood-only, or gas with gas/
wood combo

Ventilation

Direct Connect using a UL103
chimney or grease duct vent; or
Type 1 Hood.

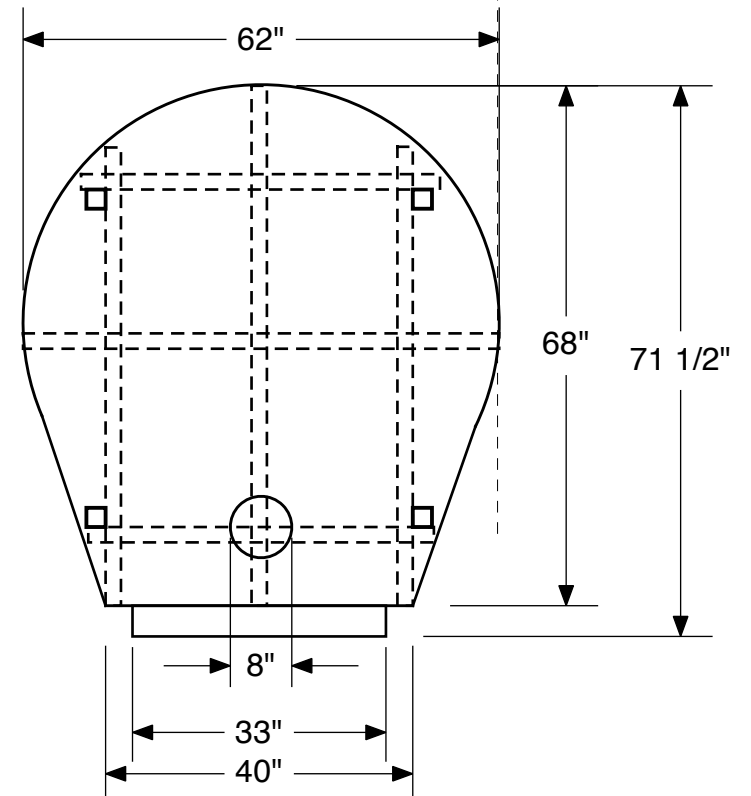

Tested and compliant with UL737,
UL2162, ANSI/NSF-4 and ANSI-Z83a